

■ BIBUS Türkiye
■ Dünya'da BIBUS



YÜKSEKLİK AYARLI MASALAR
KALDIRMA KOLONLARI

BIBUS Endüstriyel A.Ş.

İkitelli OSB Bedrettin Dalan Bulvarı Vip Plaza
Kat:2 No:43-44 / 34490 Başakşehir/İSTANBUL
Tel.: 444 20 38
Fax: +90 212 249 88 34
info@bibus.com.tr
www.bibus.com.tr



BIBUS TR - YÜKSEKLİK AYARLI MASALAR VE KOLONLAR - 11/2020

BIBUS Teknoloji

Başarınızı Destekliyoruz...

"Hidrolik, Pnömatik ve Mekatronik bileşenlerin ve sistemlerin dağıtım, geliştirilmesi ve üretilmesinde 60 yıldan fazla süredir edindiğimiz deneyimler, BIBUS' u sektörde lider tedarikçi haline getirmiştir."

Supporting Your Success...

"Over 60 years of experience in the distribution, development and manufacture of hydraulic, pneumatic and mechatronic components and systems have made BIBUS a leading provider in the industry."



tek tedarikçi
one supplier



tek temas
one contact



tek sorumluluk
one responsibility



BIBUS Türkiye

Hakkımızda

BIBUS Endüstriyel Ürünleri San. ve Tic. A.Ş.; 25 yıldan fazla deneyime sahip TMG Pnömatik Hidrolik Ltd. Sti. (Türkiye) ve 70 yıldan fazla deneyime sahip BIBUS AG Group (İsviçre) firmalarının ortak girişimleri sonucu 2011 yılında kurulmuştur. Bibus Otomasyon, alanında uzman 40'dan fazla markanın; Pnömatik, Mekatronik, Hidrolik ve Çevre Teknolojileri konularında Türkiye distribütörlüğünü gerçekleştirmektedir.

Her geçen yıl büyüyen kadrosu, bünyesine kattığı yeni markalar ve genişleyen ürün gruplarıyla, üretim ve montajlarınızda daha hızlı, üretken, verimli, güvenilir, dayanıklı, ergonomik çözümler sunarak; "BAŞARINIZI DESTEKLİYORUZ" sloganıyla faaliyet göstermektedir.

Geniş ürün yelpazesıyla;

- Yüksek derecede mühendislik desteği,
- Tedarik desteği,
- Eğitim,
- Sistem entegrasyonu,
- Servis,
- Teknik danışmanlık hizmetleri sunmaktadır.

Vizyon

"Başarınızı Destekliyoruz" sloganıyla faaliyet gösterdiğimiz alanlarda Türkiye'deki lider çözüm ortağı olmak

Misyon

Müşterilerimizi mühendislik, lojistik ve üstün hizmetlerimizle destekleyerek; sektörde başarılı olmaları için tüm gücümüzle çalışmak

İş Alanları

- Pnömatik
- Mekatronik
- Hidrolik
- Çevre Teknolojileri

Ürün Grupları

- Lineer Aktüatörler
- Lineer Raylar ve Yataklamalar
- Darbe Emiciler
- Güç Aktarım Elemanları
- Alüminyum Profil Sistemleri
- Mobil Hidrolik
- Çevre Teknolojileri



AHEAD OF THE FIELD

BIBUS has promoted the industrialization and standardization of the domestic electrical lifting desks industry.



CUSTOMIZATION

With experienced engineering groups, BIBUS is able to customize for its customers innovation.



FINEST WORKMANSHIP

BIBUS pays extremely close attention to details to create the high-quality of products. We focus on research and design, the best raw materials, precise production as well as full extensive tests. A warranty for 5 years is provided.



INNOVATIVE RESEARCH

BIBUS has three R&D centers in Xinchang, Hangzhou and Taiwan with over 200 engineers. Over 400 projects were patented with the cooperation with European and American experts and famous institutions.



PRODUCTION CAPACITY

With fully automatic production lines, BIBUS is capable of timely delivery to domestic and foreign customers with million annual production scale.



GLOBAL BRANCHES

BIBUS has subsidiaries and production bases in Europe, America and Asia, aiming at meeting all our customers' requirements on time. Our services and quality have gained recognition in over 100 countries and thousands of customers worldwide.



STRONG SENSE OF SOCIAL DUTIES

BIBUS takes its corporate social responsibility seriously, which include philanthropic efforts, employee, tax and environmental issues, and give back to society, customers, stockholders and staffs.



INTELLIGENT CYBER SYSTEMS

Bluetooth 5.0 module is connected to the control box of each electric adjustable desk, which is combined with an intelligent gateway to realize the network of adjustable desks and unified controls, station booking, the adjustable desk uses data cloud management.



SMART BOOKING

The smart adjustable desk can be booked through a work card or a mobile phone. If you leave with your phone or work card, the reservation will be canceled automatically.



INTELLIGENT ANTI-COLLISION TECHNOLOGY

BIBUS develops its own intelligent voice control system to control the operation of the electric adjustable desk.



MOBILE APP

Our APP provides the way to control the adjustable desks more intelligent and convenient. By Bluetooth or QR code scanning, you can change the height of desks, set the memory of the height, use the sedentary reminder and so on.



INTELLIGENT ANTI-COLLISION TECHNOLOGY

When the electric adjustable desk touches an object during operation, the anti-collision system will activate and immediately stop the movement of the table to prevent collision and injury to the user or the table itself.



GREEN ENERGY-SAVING AND ENVIRONMENTAL PROTECTION

0.1W standby consumption: BIBUS applies advanced power management technology to all control boxes to reduce standby power consumption of the lifting system.
PVC free: The cables for the adjustable desk of BIBUS are PVC free. We pay attention to environmental protection and your health.

CERTIFICATION

BIBUS have passed ISO9001, ISO14001, ISO27001, OHSAS18001 and other management systems, and our products have passed UL, CE, ROHS, SAA, PSE, KC, BIFMA and other international certifications.





JB35TS-R13S

DOUBLE-MOTOR OFFICE DESKS

SURFACE COLOR



Black / White / Silver

Accept color customization

TECHNICAL PARAMETER

↕ Height (mm)	↔ Width (mm)
595 ~ 1245	1080 ~ 1800
⚡ Speed (mm/s)	🔊 Noise (dB)
40	<50
⚖️ Load Capacity (N)	
1250	

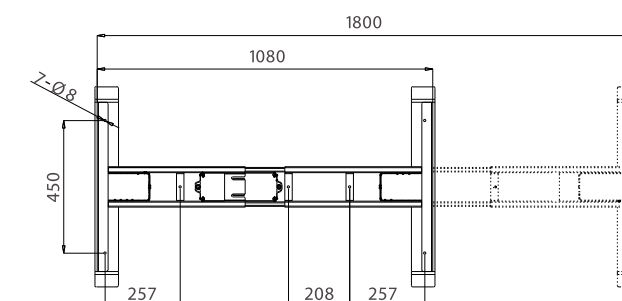
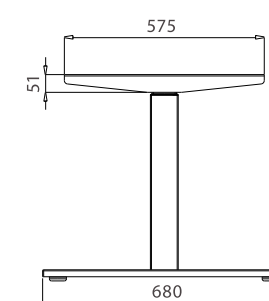
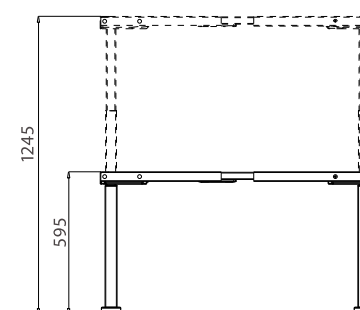

JC35TS-EZ3.0

QUICK INSTALL DESKS

SURFACE COLOR



Black / White / Silver

Accept color customization

INSTALLATION STEPS



TECHNICAL PARAMETER

Height (mm)	605 ~ 1255	Width (mm)	1165 ~ 1565
Speed (mm/s)	40	Noise (dB)	<50
Load Capacity (N)	1200		

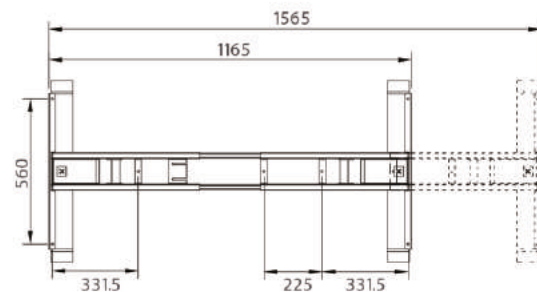
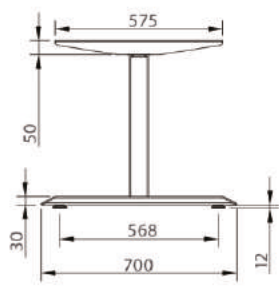
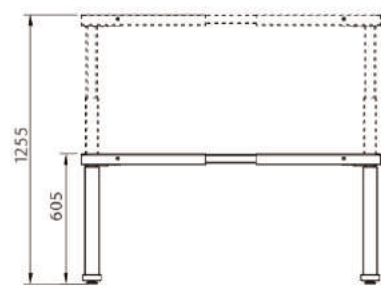

JC35TS-R13RF

FAST ADJUSTABLE DESKS

SURFACE COLOR



Black / White / Silver

Accept color customization

TECHNICAL PARAMETER

Height (mm)	595 ~ 1245	Width (mm)	1080 ~ 1800
Speed (mm/s)	80	Noise (dB)	≤55
Load Capacity (N)	800		

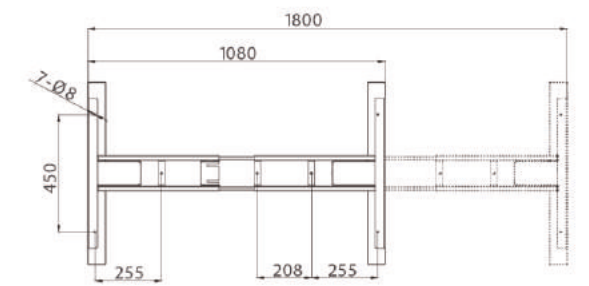
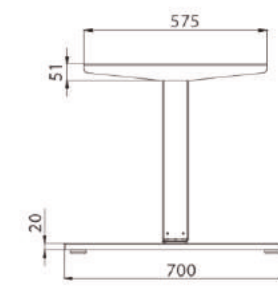
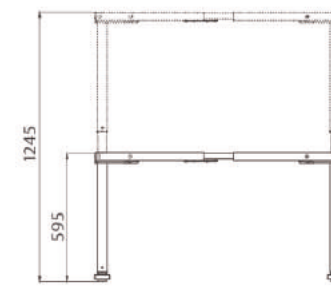

JSSY-S22S

HAND-CRANK DESKS

SURFACE COLOR



Black / White / Silver

Accept color customization

TECHNICAL PARAMETER

↑↓ Height (mm)	690 ~ 1150	≡ Width (mm)	1010 ~ 1450
⚡ Speed (mm/cycle)	16	⚖ Load Capacity (N)	700

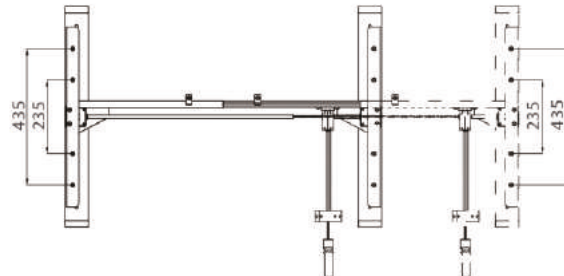
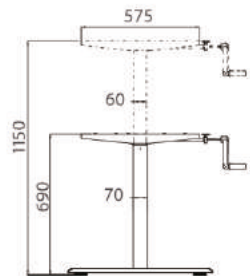
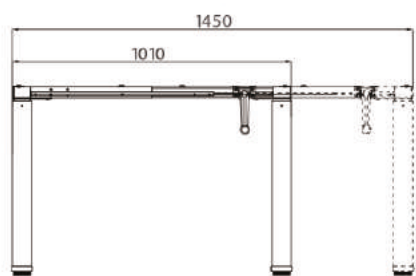

JC35TS-S13R-TH

SINGLE-MOTOR ADJUSTABLE DESKS

SURFACE COLOR



Black / White / Silver

Accept color customization

TECHNICAL PARAMETER

↑↓ Height (mm)	696 ~ 1196	≡ Width (mm)	1160 ~ 1560
⚡ Speed (mm/s)	32	🔊 Noise (dB)	≤53
⚖ Load Capacity (N)	800		

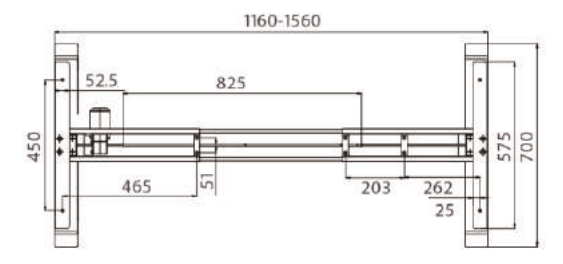
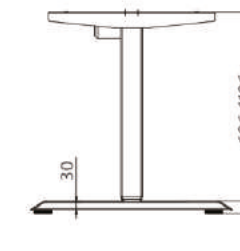
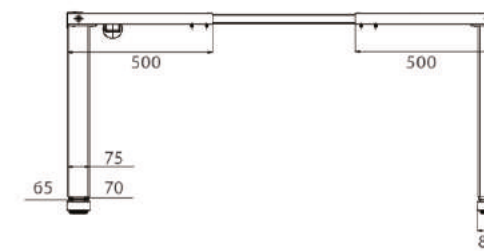



JC35TT-R13S-120°

THREE-MOTORS OFFICE DESKS
OF JC35TT SERIES

SURFACE COLOR



Black / White / Silver

Accept color customization

TECHNICAL PARAMETER

Height (mm)

595 ~ 1245

Speed (mm/s)

40

Load Capacity (N)

1500

Width (mm)

1080 ~ 1800

Noise (dB)

<50

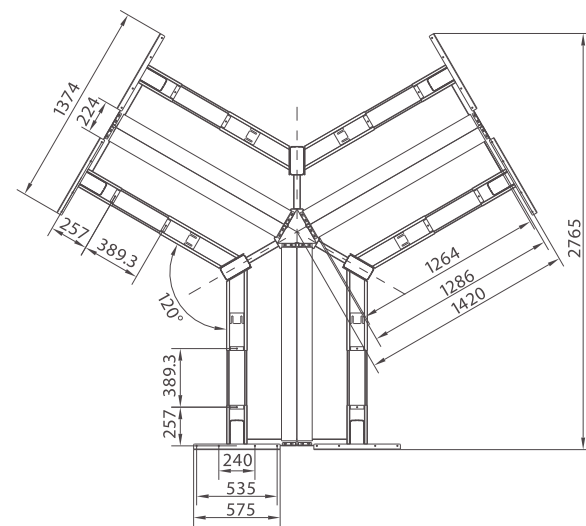
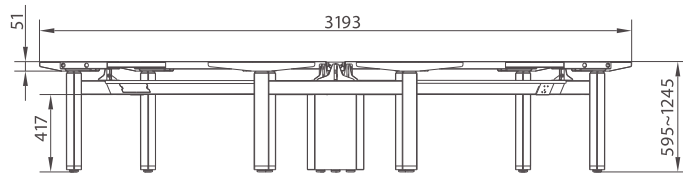

JC35TT-C13S-120°



JC35TT-R13R-90°



JC35TT-R12S-180°



Width (mm)

1050 ~ 1900

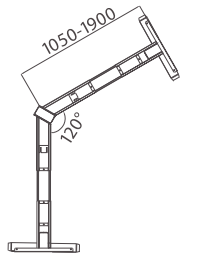
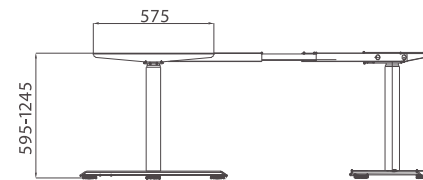

Width (mm)

1080 ~ 1800

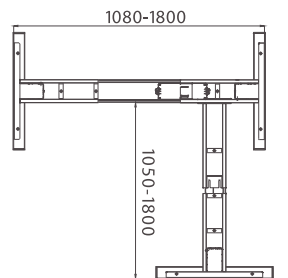
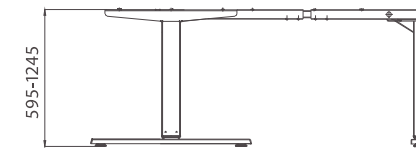

Width (mm)

1995 ~ 2995

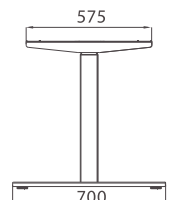
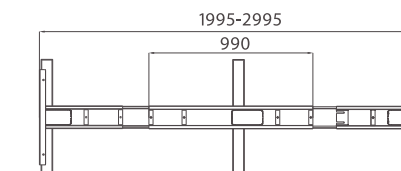
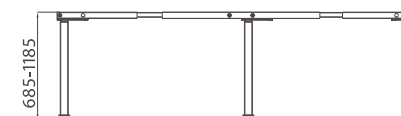



JC35TF-R13S-2

FOUR-MOTORS OFFICE DESKS
OF JC35TF SERIES

SURFACE COLOR



Black / White / Silver

Accept color customization

TECHNICAL PARAMETER			
	Height	(mm)	
	595 ~ 1245		
	Width	(mm)	
	1100 ~ 1700		
	Speed	(mm/s)	
	40		
	Noise	(dB)	
	<50		
	Load Capacity	(N)	
	1250		

DETAIL DISPLAY

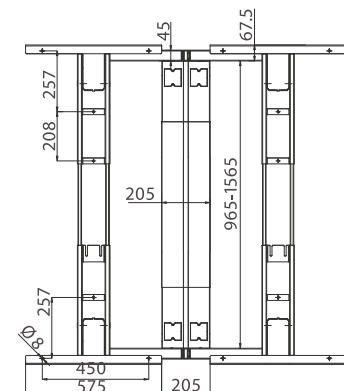
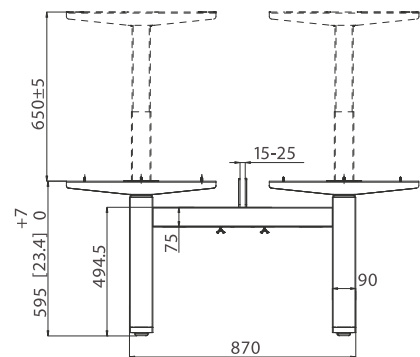
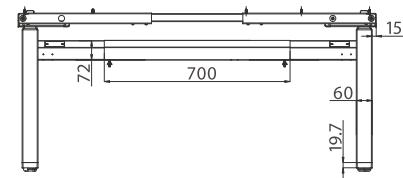
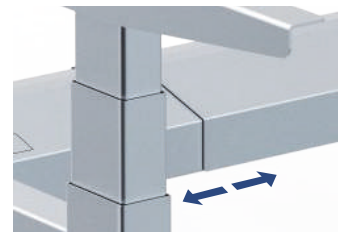

JC35TF-R13S-4

FOUR-MOTORS OFFICE DESKS
OF JC35TF SERIES

SURFACE COLOR



Black / White / Silver

Accept color customization

TECHNICAL PARAMETER			
	Height	(mm)	
	595 ~ 1245		
	Width	(mm)	
	1100 ~ 1700		
	Speed	(mm/s)	
	40		
	Noise	(dB)	
	<50		
	Load Capacity	(N)	
	1250		

DETAIL DISPLAY

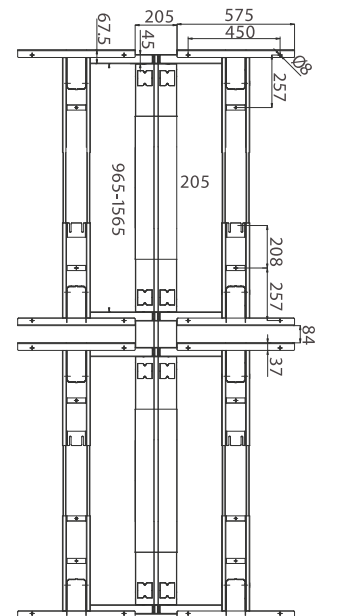
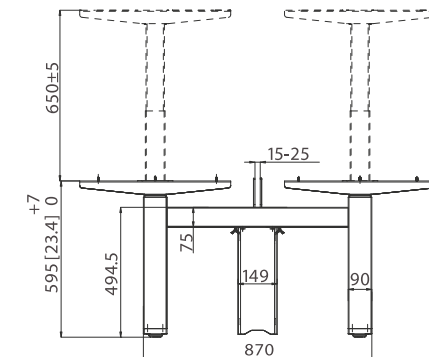
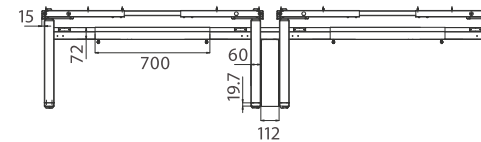
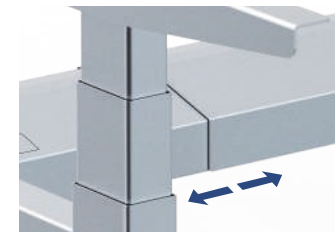

JC35TO-S33S

SINGLE-MOTOR ADJUSTABLE DESKS

SURFACE COLOR

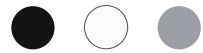

Black / White / Silver

Accept color customization

TECHNICAL PARAMETER

Height (mm)	Noise (dB)
585 ~ 1235	<50
Speed (mm/s)	Load Capacity (N)
40	800

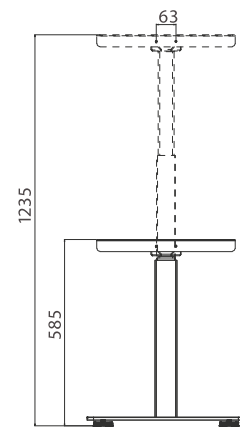
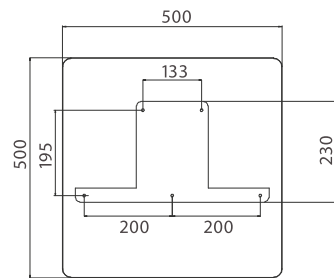
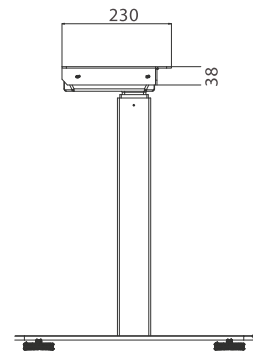

JC35SD

DESK CONVERTER

SURFACE COLOR



Black / White

TECHNICAL PARAMETER

Height (mm)	Noise (dB)
85 ~ 525	<50
Speed (mm/s)	Load Capacity (kg)
35	50

JC35SD01



JC35SD02



TECHNICAL PARAMETER

Height (mm)	Noise (dB)
85 ~ 525	<50
Speed (mm/s)	Load Capacity (kg)
35	50

JC35SD03



TECHNICAL PARAMETER

Height (mm)	Noise (dB)
26 ~ 461	<50
Speed (mm/s)	Load Capacity (kg)
30	50

LIFTING COLUMN

LIFTING COLUMNS BRING INFINITE POSSIBILITIES OF INNOVATION FOR FURNITURE PRODUCTS

The Lifting column is an important component to realize intelligent lifting furniture products. It is widely used in various adjustable desks, meeting tables, negotiation tables and other intelligent products.

MULTIPLE CHOICES, CUSTOMIZED AS YOU WANT

Rectangle, square, circular, elliptical and other diversified appearance designs.
Two or Three segments columns can meet the demands of our customer's height choice.
No-hole and oil-free design, made for a better appearance and for an easier maintenance.
Compatible with BIBUS motor of comprehensive mechanical properties, high stability, high load, low noise, excellent performance.



CUSTOMIZABLE COLOR

191 COLORS ARE OPTIONAL

Multiple colors can match various application scenarios.
The actual color plate shall prevail.

CLASSIC COLORS :



RAL 9016



RAL 7045



RAL 9005



RAL 9003



RAL 9010



RAL 9018



RAL 7043



RAL 9017

MISCELLANEOUS COLORS :



RAL 9002



RAL 1000



RAL 6018



RAL 3012



RAL 7032



RAL 6027



RAL 1016



RAL 6001



RAL 3024



RAL 4006



RAL 5012



RAL 2003



RAL 6016



RAL 3001



RAL 8003



RAL 5013



RAL 8011



RAL 6028



RAL 3004



RAL 8016

3-STAGE LIFTING COLUMN

TECHNICAL PARAMETER

 Stroke (mm)	650
 Height (mm)	560 ~ 1210
 Load Capacity (N)	800
 Speed (mm/s)	40

JS36DR1-3-S

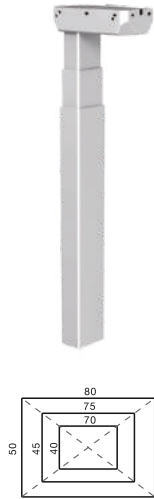

JS36DR1-3-R



JS36DR2-3-S

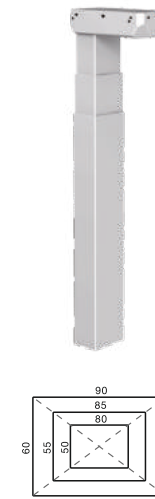

JS36DR3-3-S

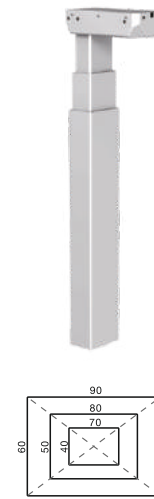

JS36DR4-3-S



JS36DR6-3-S

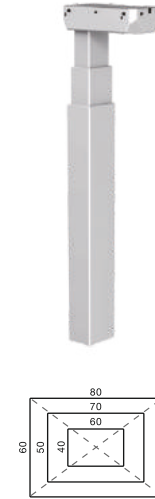

JS36DS1-3-S

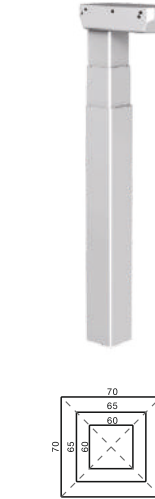

JS36DS1-3-R



JS36DS3-3-S

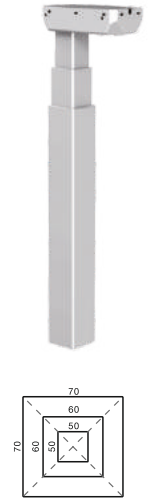

JS36DS4-3-S

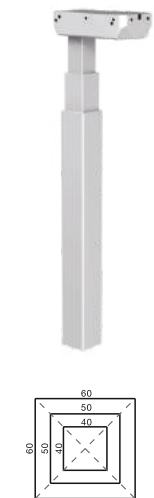

JS36DS4-3-R



JS36DS5-3-S



JS36DS9-3-S



JS36DC1-3-S



JS36DC1-3-R



JS36DE1-3-S







JS36DE2-3-S



2-STAGE LIFTING COLUMN

TECHNICAL PARAMETER

 Stroke	(mm)
500	
 Height	(mm)
650 ~ 1150	
 Load Capacity	(N)
800	
 Speed	(mm/s)
32	

JS36DR1-2-S

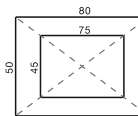

JS36DR1-2-R

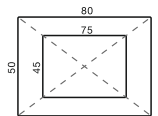

JS36DS5-2-S

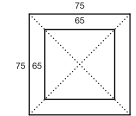

JS36DS9-2-S

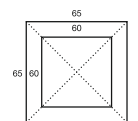
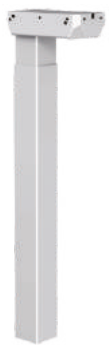

JS36DC1-2-S

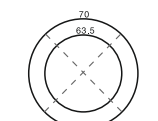



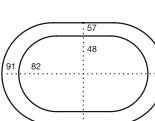

JS36DE1-2-S



OTHER LIFTING COLUMN

TECHNICAL PARAMETER

 Stroke	(mm)
660	
 Height	(mm)
518 ~ 1178	

 Load Capacity	(N)
800	
 Section size	(mm)
55x85/60x90/65x95	

 Speed	(mm/s)
40	



JS36ZR4-3-S







JC35EN-2K



TECHNICAL PARAMETER

 Stroke	(mm)
400	
 Height	(mm)
650 ~ 1050	



 Load Capacity	(N)
1500	
 Bending moment	(NM)
dynamic.500/static.1000	



 Speed	(mm/s)
30	
 Section size	(mm)
145x112/164x131	



JC35EN3A



TECHNICAL PARAMETER

 Stroke	(mm)
665	
 Height	(mm)
525 ~ 1190	

 Load Capacity	(N)
1000	
 Bending moment	(NM)
dynamic.500/static.1000	

 Speed	(mm/s)
35	
 Section size	(mm)
125.3x92.3/130.3x163.3/150x183	

CONTROL BOX



JCB36N1



JCB36N2



JCB36N3



JCB36N4



JCB35NS1



JCB35NS2



JCB36N2C



JCB36M

Model	JCB36N1	JCB36N2	JCB36N3	JCB36N4	JCB35NS1	JCB35NS2	JCB36N2C	JCB36M
Column connect No.	1~2	1~2	1~3	1~4	1	1~2	1~2	1~2
Output Voltage (VDC)	29	33	33	33	33	33	33	24
Input Voltage (V)	110/230	110/230	110/230	110-230	110-230	110/230	110/230	18-33
Transformer power (W)	200	400	500	600	130	400	400	144

HANDSET



JCHT35K

- 4 Memory Buttons
- Black
- LED Displays



JCHT35K9

- 4 Memory Buttons
- Black
- LED Displays
- USB Charger



JCHT35K11

- 3 Memory Buttons
- Water-proof on the Front Side
- Silicone Button
- 34 Degree Mounting Angle
- Black / White / Grey / Green



JCHT35K22

- 3 Memory Buttons
- Water-proof on the Front Side
- Silicone Button
- 90 Degree Mounting Angle
- Black / White / Grey / Green



JCHT35K24A

- Up&Down Button
- Seesaw Button



JCHT35K24B

- Up&Down Button
- Seesaw Button
- LED Displays

HANDSET



JCHT35K24C

- 3 Memory Buttons
- Seesaw Button
- LED Displays
- USB Charger



JCHT35K24D

- 3 Memory Buttons
- Seesaw Button
- LED Displays
- Two Speed Modes
- USB Charger



JCHT35K26A

- Up&Down Button
- Side Mounted
- Polychromatic Collocation
- Silicone Button



JCHT35K26A

- Up&Down Button
- Top Mounted
- Polychromatic Collocation
- Silicone Button



JCHT35K26B

- Up&Down Button
- Side Mounted
- Polychromatic Collocation
- LED Displays
- Silicone Button



JCHT35K26B

- Up&Down Button
- Top Mounted
- Polychromatic Collocation
- LED Displays
- Silicone Button

HANDSET



JCHT35K26C

- 3 Memory Buttons
- Top Mounted
- Polychromatic Collocation
- LED Displays
- Silicone Button



JCHT35L

- Up&Down Button
- Black



JCHT35K6

- 2 Memory Buttons
- Operate by Tilting for Up and Down
- OLED Displays
- Sedentary Reminder



JCHT35K20

- Operate by Tilting for Up and Down
- Acrylic Material
- With Different Back Light Color Options
- Accept Customized Shape

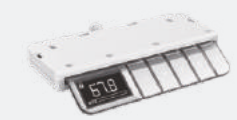

JCHT35K23

- 2 Memory Buttons
- Acrylic Material
- With Different Back Light Color Options
- Sedentary Reminder
- OLED Displays



JCHT35M6

- 3 Memory Buttons
- Touch Screen
- OLED Displays
- Operate by Rotating for Up and Down
- Sedentary Reminder

HANDSET



JCHT35M5

- 4 Memory Buttons
- Touch Screen
- Extent-retract
- LED Displays



JCHT35M13

- 3 Memory Buttons
- Touch Screen
- LED Displays
- 34 or 90 Degree Mounting Angle



JCHT35K32C

- 3 Memory Buttons
- Water-proof on the Front Side
- Silicone Button
- LED Displays



JCHT35K33C

- 3 Memory Buttons
- Water-proof on the Front Side
- Silicone Button
- LED Displays



JCHT35M18C

- 3 Memory Buttons
- Water-proof on the Front Side
- Touch Screen
- Light Wake
- LED Displays



JCHT35M19C

- 3 Memory Buttons
- Water-proof on the Front Side
- Touch Screen
- Light Wake
- LED Display

ACCESSORIES

CUSTOMIZED LIFTING SCREEN



Jc35SP01

- Length: 900-1500mm
- Width: 600mm
- Thickness : 15-30mm
- Load Capacity: 100N
- Stroke : 485mm

2.4G WIRELESS RECEIVER BOX



JcP35N-2.4G

- Input power: 5V
- Remote control frequency : 2.4GHz
- Transmission distance : 8M

LITHIUM BATTERY BOX



JcP35PA-B-3

- Mobile office
- Low power consumption
- USB charger
- Safe & fast charging

BLUETOOTH RECEIVER BOX



JcP35N-BLT

- Plug in the Bluetooth receiver box on the control box, then turn on the Bluetooth and control the adjustable table through the APP on mobile phone

CABLE CHAIN

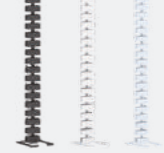

J-TSXG01

- Standard size(mm) : 90*120*1400
- Accept any customized length
- Color: White/Black/Chroma

USB CHARGING BOX



JcP35U

- Color: Black / White
- Charging for Mobile device, desktop fan and so on
- Tighten with screws or fix with clamps
- Fit with JcB35NS2 control box

SIX AXIS SENSOR



JcB35N-6AXIS

- Intelligent anti-collision accessories
- High sensitivity, stable operation

WIRE MANAGEMENT

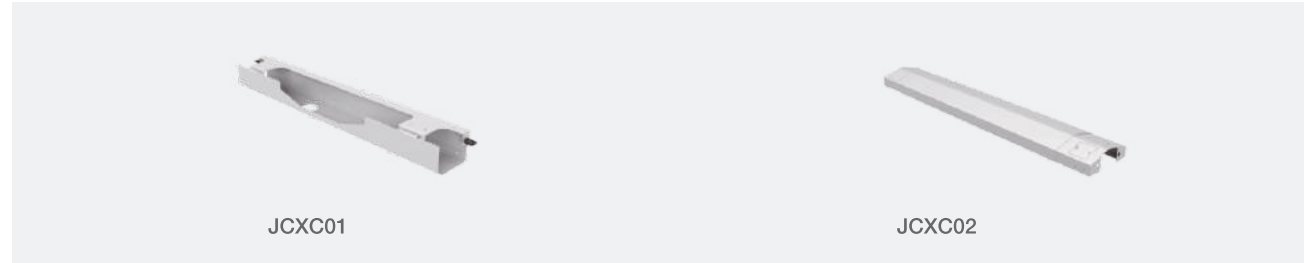

JCXC01

- Length : 762mm
- Width : 99.8mm
- Height : 74.5mm

JCXC02

- Length : 950mm
- Width : 205mm
- Height : 73.5mm

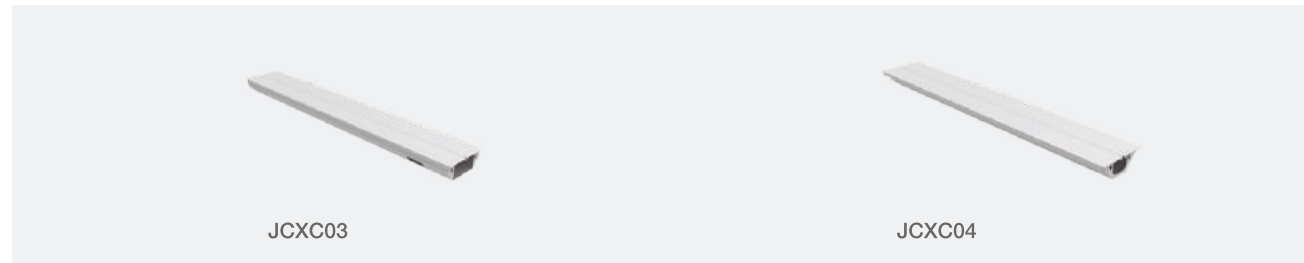

JCXC03

- Length : 1351mm
- Width : 200mm
- Height : 72mm

JCXC04

- Length : 1264mm
- Width : 192.4mm
- Height : 71.8mm

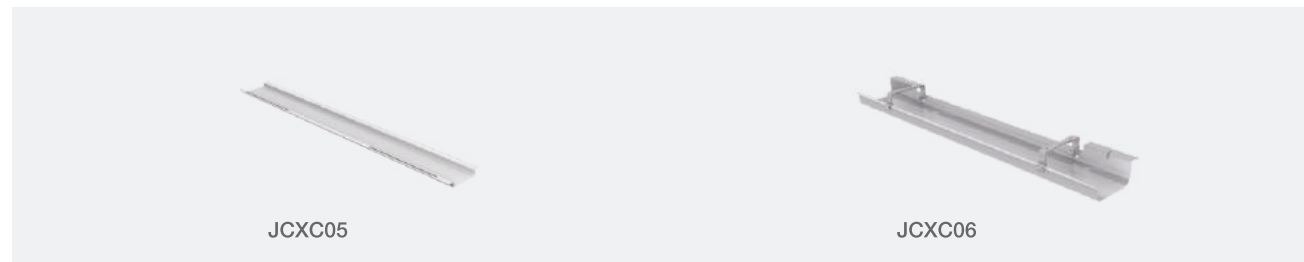

JCXC05

- Length : 1000mm
- Width : 136mm
- Height : 18mm

JCXC06

- Length : 900mm
- Width : 173mm
- Height : 60mm

FOOT SERIES



JCF132

- Length : 560mm
- Width : 84mm
- Hole Pattern : 32.5*32.5mm

JCF084

- Length : 580mm
- Width : 80mm
- Hole Pattern : 52*26mm

JCF254

- Length : 700mm
- Width : 85mm
- Hole Pattern : 58*34mm



JCF197

- Length : 700mm
- Width : 60mm
- Hole Pattern : 14*14mm

JCF095

- Length : 700mm
- Width : 80mm
- Hole Pattern : 58*34mm

JCF073

- Length : 975mm/625mm
- Width : 80mm
- Hole Pattern : 58*34mm



JCF072

- Length : 700mm
- Width : 78mm
- Hole Pattern : 58*34mm

JCF093

- Length : 603mm
- Width : 73mm
- Hole Pattern : 52*26mm

JCF138

- Length : 700mm
- Width : 80mm
- Hole Pattern : 58*34mm

CONTROL SYSTEM

START A HEALTHY OFFICES STATE, MAKE YOUR LIFE FULL OF POSSIBILITIES

Up & Down control / Sit & Stand reminder / Office data statistics / used in mobile and computer

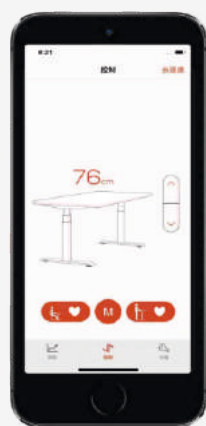

AIDESK Control System

- Control UP & DOWN by mobile phone
- Applicable for android and IOS system
- Sedentary reminder function



AIWORKING Desk Control Software

- Control by computer software
- Display the height
- Show the standing-time and calorie-buring results
- To memory the height of standing and sitting
- Statistical datas and health management

Genel Merkez

Switzerland
BIBUS AG
Allmendstrasse 26
8320 FEHRALTORF
Tel. +41 44 877 50 11
Fax +41 44 877 50 19
E-mail: info.bag@bibus.ch
www.bibus.ch

Switzerland
BIBUS HYDRAULIK AG
Allmendstrasse 26
8320 FEHRALTORF
Tel. +41 44 877 52 11
Fax +41 44 877 52 19
E-mail: bibushydraulik@bibus.ch
www.bibushydraulik.ch

Dünya'da BIBUS

Austria
BIBUS Austria GmbH
Eduard Klinger-Strasse 12
3423 ST. ANDRÄ-WÖRDERN
Tel. +43 2242 33 388
Fax +43 2242 33 388 10
E-mail: info@bibus.at
www.bibus.at

Latvia
BIBUS Baltics SIA
Kleistu iela 24
1067 RIGA
Tel. +371 67 63 05 01
Fax. +371 67 63 05 01
E-mail: info@bibusbaltics.eu
www.bibusbaltics.eu

Belarus
BIBUS (BY) COOO
8th Per. Ilyicha 13a, office 2.1
246013 GOMEL
Tel. +375 232 29 72 05
Fax +375 232 29 71 81
E-mail: info@bibus.by
www.bibus.by

Bosnia
BIBUS doo
Karadordeva bb
BA 76311 DVOROVI -
BIJELJINA - BOSNIA
Tel. +387 55 423 444
Fax +387 55 423 444
E-mail: info@bibus.ba
www.bibus.ba

Slovenia
INOTEH d.o.o.
K Železnici 7
SI-2345 BISTRICA OB DRAVI
Tel. +386 2 665 11 31
Fax +386 2 665 20 81
E-mail: info@inoteh.si
www.inoteh.si

China
BIBUS Shanghai Mec., Ltd.
2nd Floor, Block 9, No. 188
Shanfeng Road 201508
Tel. +86 21 5803 9270
Fax +86 21 6729 8667
E-mail: info@bibuschina.cn
www.bibuschina.cn

Croatia
BIBUS Zagreb d.o.o.
Anina 91
HR-10000 ZAGREB
Tel. +385 1 381 80 04
Fax +385 1 381 80 05
E-mail: bibus@bibus.hr
www.bibus.hr

Czech Republic
BIBUS s.r.o.
Videnska 125
619 00 BRNO
Tel. +420 547 125 300
Fax +420 547 125 310
E-mail: bibus@bibus.cz
www.bibus.cz

Denmark
BIBUS Sindby A/S
Edisonvej 11
7100 VEJLE
Tel. +45 75 8 8 21 22
Fax +45 75 88 22 40
E-mail: bibus@bibus.dk
www.bibus-sindby.dk

France
BIBUS France S.A.S.
Zl du Chapotin
233, rue des Frères Voisin
69970 CHAPONNAY
Tel. +33 4 7896 80 00
Fax +33 4 7896 80 01
E-mail: contact@bibusfrance.fr
www.bibusfrance.fr

Germany
BIBUS GmbH
Max-Eyth-Strasse 41/1
89231 NEU-ULM
Tel. +49 731 20 76 90
Fax +49 731 20 76 96 20
E-mail: info@bibus.de
www.bibus.de

Germany
SAUER BIBUS GmbH
Lise-Meitner-Ring 13
DE-89231 NEU-ULM
Tel. +49 731 1896 0
Fax +49 713 1896 199
E-mail: info@sauerbibus.de
www.sauerbibus.de

Germany
WESER-PUMPEN GmbH
Güterstrasse 10
27777 GANDERKESEE
Tel. +49 4222 947 510-0
Fax +49 4222 947 510-10
E-mail: info@weser-pumpen.de
www.weser-pumpen.de

Great Britain
BIBUS (UK) Ltd
20 Saha Mills
WOOBURN GREEN Bucks
HP10 0PF
Tel. +44 1628 533 300
Fax +44 1628 533 377
E-mail: info@bibus.uk
www.bibus.uk

Hungary
BIBUS Kft
Almáskert út 9
2220 VECSÉS
Tel. +36 1 265 27 33
Fax +36 1 264 89 00
E-mail: info@bibus.hu
www.bibus.hu

Italy
BIBUS ITALIA SRL
Via Tosarelli, 334/2
40055 VILLANOVA DI
CASTENASO (BO)
Tel. +39 051 893958
Fax +39 051 0822575
E-mail: info@bibus.it
www.bibus.it

India
BIBUS INDIA Pvt. Ltd.
Yellupura Village, Kasaba Hobli
Near KSSIDC Industrial Area
Doddaballapura Taluk
No.102/25 1st Floor
BANGALORE - 561 203
Tel. +91 80 28562008
E-mail: info@bibus.in
www.bibus.in

Malaysia
BIBUS Malaysia Sdn. Bhd.
7, Jalan Kartunis, U1/47
Glenmarie Temasya Industrial Park
40150 SHAH ALAM
Tel. +60 3 5569 70 77
Fax +60 3 5569 70 66
E-mail: sales@bibus.my
www.bibus.my

Netherlands
BIBUS Romicon B.V.
Vlijtweg 10A 8191JP
Wapenfeld
Tel. +31 38 447 91 81
E-mail: info@bibusromicon.nl
www.bibusromicon.nl

Poland
BIBUS MENOS Sp. z o.o.
ul. Spadochroniarzy 18
80-298 GDANSK
Tel. +48 58 660 95 70
Fax +48 58 661 71 32
E-mail: info@bibusmenos.pl
www.bibusmenos.pl

Portugal
BIBUS Portugal, Lda
Rua Ponte da Pedra, 240 - C4
4470-108 GUEIFAES - MAIA
Tel. +351 906 50 50
Fax +351 906 50 53
E-mail: info@bibus.pt
www.bibus.pt

Romania
BIBUS SES SRL
134/1 Calea Lugojului
307200 GHIRODA, TIMIS
Tel. +40 356 446 500
Fax +40 356 446 660
E-mail: office@bibus.ro
www.bibus.ro

Russia
BIBUS o.o.o.
Zemskaya street 94
198205 ST. PETERSBURG
Tel. +7 812 309 41 51
Fax +7 812 309 41 51
E-mail: info@bibus.ru
www.bibus.ru

Slovakia
BIBUS SK s.r.o.
Trnavská 31
949 01 NITRA
Tel. +421 37 777 79 11
Fax +421 37 777 79 19
E-mail: sale@bibus.sk
www.bibus.sk

Bulgaria
BIBUS Bulgaria Ltd.
2 Blvd. Prof. Tzvetan Lazarov,
Floor 2
1574 SOFIA
Tel. +359 2 971 98 08
Fax +359 2 971 98 08
E-mail: info@bibus.bg
www.bibus.bg

Spain
BIBUS SPAIN, S.L.
Poligono Industrial Porto do Molle
Rua do Arroncal Vial C-Nave 4A
36350 NIGRAN
Tel. +34 986 24 72 86
Fax +34 986 20 92 47
E-mail: info@bibus.es
www.bibus.es

Thailand
BIBUS THAILAND Company
181/68 Soi Nuanchan
Buengkhum District 10230 Bangkok
Tel. +66 90 894 98 67
Fax. +66 2 054 65 76
info@bibus.co.th
www.bibus.co.th

Turkey
BIBUS Endüstriyel A.Ş.
İkitlelli OSB, Bedrettin Dalan Bulv.
Vip Plaza Kat:2 No:43-44 34490
Başakşehir / İstanbul
Tel. +90 444 20 38
Fax +90 212 249 88 34
E-mail: info@bibus.com.tr
www.bibus.com.tr

Turkey
BIBUS Hidrotos A.Ş.
İvedik OSB 1451. Cd. No:79
Yenimahalle/Ankara
Tel : +90 312 354 29 27
Fax: +90 312 354 91 61
E-mail: hidrotos@bibus.com.tr
www.bibushidrotos.com.tr

Ukraina
BIBUS Ukraine TOV
Odesa Street 22
08136 Kiev-Svyatoshynsky
District Kryukivshchina
Tel. +380 44 545 44 04
Fax +380 44 545 54 83
E-mail: info@bibus.ua
www.bibus.ua

Vietnam
BIBUS VIETNAM E&C Co. Ltd.
No. 10, Lot K, Hoang Quoc Viet Street
Phu My Ward, District 7 Ho Chi Minh City
Tel:+84 8 378 506 27
Fax: +84 8 378 506 28
E-mail: info@bibus.vn
www.bibus.vn